



**STRAUSS&CO.**  
Turning precision into value

**50**

years of precision

**NEEPIN**  **DENTAL**  
ΕΙΣΑΓΩΓΕΣ ΟΔΟΝΤΙΑΤΡΙΚΩΝ ΕΙΔΩΝ

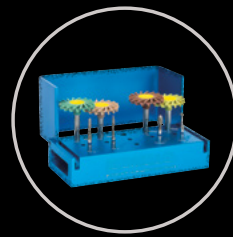
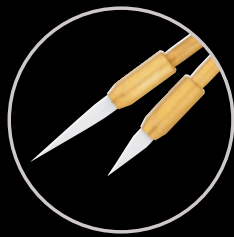



# FG Diamond Burs



Cat. No.	A0	A1	A2	A3	A4	A5
Code	801-009	801-012	801-014	801-018	801-022	801-032
ISO No.	001-009	001-012	001-014	001-018	001-022	001-032
Head Size	009	012	014	018	022	032
Head Length						
Total Length	19	19	19	19	19	19
S. Fine			▲	▲		
Fine			▼	▼		
Medium	◇		◇			◇
Coarse	▽	▽	▽	▽	▽	▽
S. Coarse						

**Round**



Cat. No.	A11
Code	802-012
ISO No.	002-012
Head Size	012
Head Length	2.5
Total Length	19
S. Fine	
Fine	
Medium	◇
Coarse	▽
S. Coarse	

**Round + Neck**



Cat. No.	A1L	A2L	A3L	A4L	A5L
Code	801L-012	801L-014	801L-018	801L-022	801L-032
ISO No.	001-012	001-014	001-018	001-022	001-032
Head Size	012	014	018	022	032
Head Length					
Total Length	24	24	24	24	24
S. Fine					
Fine					
Medium					
Coarse	▽	▽	▽	▽	▽
S. Coarse					

**Surgical Length Round**



Cat. No.	B0	B1	B2	B3	B4
Code	805-009	805-012	805-018	807-014	807-018
ISO No.	010-009	010-012	010-018	225-014	225-018
Head Size	009	012	018	014	018
Head Length	0.9	1.3	1.6	3	5
Total Length	19	19	19	19	19
S. Fine					
Fine					
Medium					
Coarse	▽	▽	▽	▽	▽
S. Coarse					

**Inverted Cone**



Cat. No.	M5	M1	M6	M2
Code	806-014	813-016	806-016S	813-018
ISO No.	032-014	032-016	032-016	032-018
Head Size	014	016	016	018
Head Length	2	1.3	2.5	2.1
Total Length	19	16	19	17
S. Fine				
Fine				
Medium				
Coarse	▽	▽	▽	▽
S. Coarse				

**Double Inverted Cone**



Cat. No.	M4
Code	811-033
ISO No.	038-033
Head Size	033
Head Length	5.5
Total Length	21
S. Fine	
Fine	
Medium	◇
Coarse	▽
S. Coarse	

**Barrel**



Cat. No.	G4	G5
Code	909-048	909-054
ISO No.	067-048	068-054
Head Size	048	054
Head Length	1	2.3
Total Length	15	19
S. Fine		
Fine		
Medium	◇	◇
Coarse		
S. Coarse		

**Round Wheel**



# FG Diamond Burs

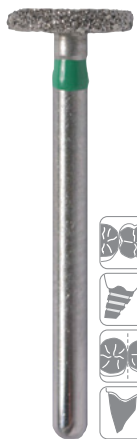

Cat. No.	G1	G2	G3
Code	818-030	818-040	818-050
ISO No.	042-030	041-040	041-050
Head Size	030	040	050
Head Length	0.8	0.7	0.7
Total Length	19	19	19
S. Fine			
Fine			
Medium	▽		▽
Coarse		▽	
S. Coarse			

Wheel



Cat. No.	BR2	BR3	BR4
Code	651-016	654-016	655-018
ISO No.	511-016	517-016	519-018
Head Size	016	016	018
Head Length	6	6	8
Total Length	17.5	18.5	20.5
S. Fine			
Fine			
Medium		▽	▽
Coarse	▽	▽	▽
S. Coarse			

Gross Reduction



Cat. No.	AB2	AB1
Code	830-014	830-016
ISO No.	237-014	237-016
Head Size	014	016
Head Length	2.5	2.5
Total Length	17	19
S. Fine		
Fine		
Medium		
Coarse	▽	▽
S. Coarse		

Pear



Cat. No.	K1	K11	K2	K2R
Code	368-016	368-018	368-023	379-023
ISO No.	257-016	257-018	257-023	277-023
Head Size	016	018	023	023
Head Length	3.3	4.5	5.3	4.4
Total Length	20	18.5	20	19
S. Fine	▽		▽	
Fine	▽		▽	
Medium				
Coarse	▽	▽	▽	▽
S. Coarse				

Egg/Football



Cat. No.	D0	D1	D2	D3	D12	D4
Code	835-008	835-010	835-016	836-012	837-010	837-014
ISO No.	109-008	109-010	109-016	110-012	111-010	111-014
Head Size	008	010	016	012	010	014
Head Length	4	4	4	5.6	8	8
Total Length	19	19	19	21	21.5	21
S. Fine						
Fine						
Medium	▽		▽			
Coarse	▽	▽	▽	▽	▽	▽
S. Coarse						

Flat End Cylinder



Cat. No.	D4R
Code	881-014
ISO No.	141-014
Head Size	014
Head Length	8
Total Length	21
S. Fine	
Fine	
Medium	
Coarse	▽
S. Coarse	

Round End Cylinder



Cat. No.	F3	Z3	F02	F11	F05	F06	F07	F1	F2
Code	845-022	846-018	847-010	847-018	848-010	848-012	848-014	848-016	848-018
ISO No.	169-022	171-018	172-010	172-018	173-010	173-012	173-014	173-016	173-018
Head Size	022	018	010	018	010	012	014	016	018
Head Length	2.5	7	8	8.5	10	10	10	10	10
Total Length	16	19.5	21.5	21	23	23	24	22.5	22.5
S. Fine									
Fine									
Medium	▽	▽				▽	▽		
Coarse	▽	▽	▽	▽	▽	▽	▽	▽	▽
S. Coarse									

Flat End Taper

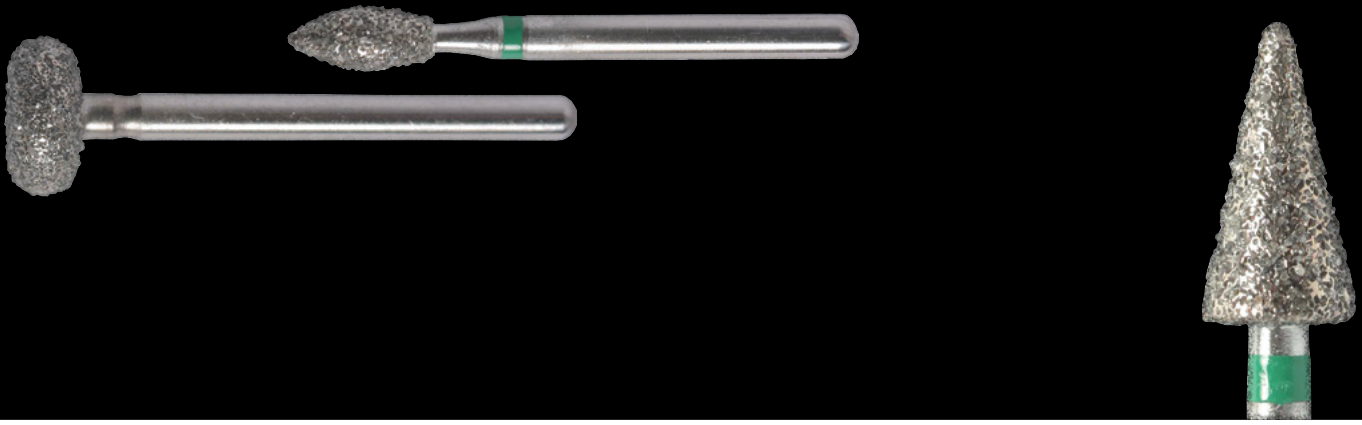

# FG Diamond Burs



Cat. No.	C1	C2	C3	C11	M3	F1R	F2R	C4
Code	855-014	855-018	855-025	856-012	856L-018	850-016	850-018	850-021
ISO No.	197-014	197-018	197-025	198-012	198-018	199-016	199-018	199-021
Head Size	014	018	025	012	018	016	018	021
Head Length	6.3	7	7	8	9	10	10	10
Total Length	21	19	21	21	21	22.5	22.5	22
S. Fine								
Fine								
Medium	▽			▽				
Coarse	▽	▽	▽	▽	▽	▽	▽	▽
S. Coarse						▽		



**Round End Taper**



Cat. No.	K3
Code	825-038
ISO No.	164-038
Head Size	038
Head Length	7
Total Length	21
S. Fine	
Fine	
Medium	
Coarse	▽
S. Coarse	



**X-Mas Tree**



Cat. No.	E1	Z12	E12	E2	Z4	E11	Z11	E31	E32	E3	Z1	Z2
Code	852-012	858-010	858-012	858-014	858-015	859-010	859-012	859-014	859-016	859L-016	859-017	859-018
ISO No.	164-012	165-010	165-012	165-014	165-015	166-010	166-012	166-014	166-016	167-016	166-017	166-018
Head Size	012	010	012	014	015	010	012	014	016	016	017	018
Head Length	5.6	8	8	8	8	10	10	10	10	10.5	10	10
Total Length	19	22	22	21	20.5	23.5	22.5	23	23	23.5	22.5	22.5
S. Fine	▽	▽	▽	▽		▽				▽		
Fine				▽						▽		
Medium												
Coarse	▽	▽	▽	▽	▽	▽	▽	▽	▽	▽	▽	▽
S. Coarse												



**Needle**



Cat. No.	E4	E8	Z5	E5	E9	E6
Code	860-013	861-014	862-013	862-014	863-023	863-016
ISO No.	247-013	248-014	249-013	249-014	249-023	250-016
Head Size	013	014	013	014	023	016
Head Length	5.2	6	8	8	9	9.5
Total Length	19	20	20	21	21	22
S. Fine				▽	▽	▽
Fine				▽	▽	▽
Medium	▽			▽	▽	▽
Coarse	▽	▽	▽	▽	▽	▽
S. Coarse						



**Flame**



Cat. No.	S11	PR1
Code	879-012	879-012
ISO No.	289-012	290-012
Head Size	012	012
Head Length	8	10
Total Length	22	23.5
S. Fine		
Fine		
Medium	▽	
Coarse	▽	▽
S. Coarse		



**Torpedo Cylinder**



# FG Diamond Burs



Cat. No.	S4	T5	T4	S2	S5	T3	T1	T2	S3	S1	T6
Code	877K-014	877K-016	877K-018	878K-014	878K-016	878K-018	878K-020	878K-022	879K-014	879K-016	879K-018
ISO No.	297-014	297-016	297-018	298-014	298-016	298-018	298-020	298-022	299-014	299-016	299-018
Head Size	014	016	018	014	016	018	020	022	014	016	018
Head Length	6.5	6.5	6.5	8	8	8	8	8	9.5	9.5	9.5
Total Length	19	18.5	19	21	20.5	20	20.5	20.5	22	22	22
S. Fine											
Fine											
Medium	▽		▽	▽	▽	▽			▽		
Coarse	▽	▽	▽	▽	▽	▽	▽	▽	▽	▽	▽
S. Coarse											

**Gingival Curettage**



Cat. No.	E71	E7	PR3
Code	885-010	885-012	879-014
ISO No.	130-010	130-012	131-014
Head Size	010	012	014
Head Length	8	8	10
Total Length	21.5	21	23
S. Fine			
Fine			
Medium		▽	
Coarse	▽	▽	▽
S. Coarse			

**Pointed Cylinder**



Cat. No.	E3R
Code	889-008
ISO No.	169-008
Head Size	008
Head Length	3
Total Length	24
S. Fine	
Fine	
Medium	
Coarse	▽
S. Coarse	

**Separation**



Cat. No.	PR12
Code	834-019
ISO No.	552-019
Head Size	019
Head Length	1X3
Total Length	20
For Depth (mm)	0.5
Fine	
Medium	▽
Coarse	
S. Coarse	

**Depth Cutting**



Cat. No.	L1
Code	851-019
ISO No.	220-019
Head Size	019
Head Length	10.2
Total Length	22
S. Fine	
Fine	
Medium	▽
Coarse	
S. Coarse	

**Safe End**



Cat. No.	K2SP	C3SP	M31SP	E5SP	E6SP
Code	T368-023	T855-025	T856-016	T862-014	T863-016
ISO No.	T257-023	T197-025	T198-016	T249-014	T249-016
Head Size	023	025	016	014	016
Head Length	5.3	7	8	8	9.5
Total Length	20	21	21	21	22
Medium	▽	▽	▽	▽	▽

**Specials - Cool Cut**



19 Hayezira St. Industrial Area, P.O.Box 2521,  
Raanana 4366363 Israel  
Tel: 972-9-7461631 | Fax: 972-9-7461636  
Email: info@strauss-co.com



Φωκίδος 51, Αθήνα 11527  
T. 210 7711605 F. 210 7754065  
e-mail: info@negrin.gr  
http://www.negrin.gr

